



CONSTRUCTION MACHINERIES & EQUIPMENT

Fastest , Safests, Largest After Market

Spare parts – Original, OEM and OES



Hitachi Construction Machinery



HAMM



VÖGELE



WIRTGEN GROUP





FORKLIFT / INDUSTRIAL TRUCK PARTS

Fastest , Safests, Largest After Market

Spare parts – Original, OEM and OES





Mobile Elevating Work Platforms (MEWPs), Personnel Lifting Platform , Manlift ,
Aerial Work Platforms (AWP) , Telehandlers, Platform Sector
SPARE PARTS – ORIGINAL- OEM- OES





VEHICLE SPARE PARTS

Fastest , Safests, Largest After Market
Spare parts – Original, OEM and OES





TRACTOR AND AGRI MACHINERIES SPARE PARTS

Fastest , Safests, Largest After Market

Spare parts – Original, OEM and OES





WHO WE ARE? QUI NOUS SOMMES?



Leading Team with more than 30 years Global Business Experience;
Équipe dirigeante avec plus de 30 ans d'expérience commerciale mondiale



Sidy G. DIOP
Chairman



Faruk AKSOY
Partner & CEO



WHO WE ARE? Sidy G. DIOP -Chairman



Leading Team with more than 30 years Global Business Experience;

Several years CEO, Board Member , General Manager in Global Groups with head quarter in Germany (Honeywell, Transnorm, TLD, Hasemann, Greif Werk, Volkswagen)

Founder of several companies in Germany, Senegal, Dubai, India and Turkey

Sidy G. DIOP
Chairman





Who we are ? SIFTAMEC MACHINERY FARUK AKSOY (CEO & Partner)



TÜRKİYE Construction Equipment Distributors & Manufacturers Association



Materials Handling, Storage & Industrial Equipment Association of TÜRKİYE



T.C. SANAYİ VE TEKNOLOJİ BAKANLIĞI

2002 -2017 İMDER & İSDER (More than 120 members)

Founder , Secretary General and Vice President for more than 15 years of Turkish Construction Equipment Manufacturers, Distributors and Rental İMDER & Material Handling, Storage and Industrial Equipment Associations İSDER

**Ministry of Industry and Technology of the Republic of Turkey
2003- 2018 Ministry of Industry "MAKTEK-Machinery Sector" Chairman of the Technical Committee,
Member of the Presidential Economic Coordinating Council of Turkey.**



The Union of Chambers and Commodity Exchanges of Turkey

2007-2017 TOBB - Union of Chambers and Commodity Exchanges of Turkey (Vice President)



RUSSIA -



GERMANY



S.KOREA



CHINA



JAPAN



Confederation of Indian Industry
125 Years: 1895-2020



BRAZIL

ASSOCIAÇÃO BRASILEIRA DE TECNOLOGIA PARA CONSTRUÇÃO E MINERAÇÃO



European materials handling federation

FEM – European Federation - BELGIUM Executive Board Membership



COMMITTEE FOR EUROPEAN CONSTRUCTION EQUIPMENT

CECE – European Federation - BELGIUM – Executive Board Membership



EUROPEAN RENTAL ASSOCIATION

ERA – European Federation - BELGIUM – Executive Board Membership

UNITED STATES OF AMERICA



Association of Equipment Manufacturers



Association Equipment Distributors



American Rental Association



THE INDUSTRY THAT'S

WHICH SECTORS?

- 1. Construction, agricultural machinery, equipment, vehicles and spare parts**
- 2. Construction Equipment and Machineries**
- 3. Material Handling, Access Equipment , Forklifts**
- 4. Agricultural industry and equipment**
- 5. Contract construction, infrastructure, superstructure**
- 6. Construction and building materials**
- 7. Energy and electricity, Lighting**
- 8. Medicine and health industry**
- 9. Food industry and supermarket**
- 10. Cosmetics and personal care products**
- 11. Environment and Process Industry**
- 12. Solutions for logistics automation, systems and control**
- 13. Consultations | Production | Distribution activities | Investments**



Construction, Agri Machineries, Equipment, Vehicle & Spare Parts





OUR MANUFACTURING FIELD AND PARTNER FACTORIES IN TÜRKİYE





TRUCK MOUNTED PLATFORMS – MANLIFTS

10M TO 53M Manufacturing in TÜRKİYE

www.uzmanlarplatform.com

HT 10



HT 14



HT 14



HT 14



HT 16



HT 18



HT 20



HT 22



HT 26



HTF 30



HT 30



HT 37



HTF 45



53 m



**Uzmanlar
Platform**

www.uzmanlarplatform.com
info@uzmanlarplatform.com



GERMAN HARDWARE AND CONSTRUCTION TOOLS

Distributorship & Manufacturing for ECOWAS



LIGHT CONSTRUCTION EQUIPMENT

■ Compaction Machines



■ Floor Cutting Machines



■ Lighting Towers



■ Concrete Machines



■ Rebar Cutting and Bending Machines



■ Pavement Cutting and Joint Cleaning Machines





CONSTRUCTION EQUIPMENT AND MACHINERY POWER GENERATORS - SPARE PARTS





MATERIAL HANDLING EQUIPMENT

Levage, chargement, déchargement, stockage, manutention, etc
Distributorship & Manufacturing for ECOWAS

Turkey
Discover the potential





MUNICIPAL EQUIPMENT AND MACHINERIES ÉQUIPEMENT MUNICIPAL ET MACHINERIES Distributorship & Manufacturing for ECOWAS

Turkey
Discover
the potential





ALL KIND OF TRUCK MOUNTED MACHINIES AND PRODUCTS



Fire Trucks



Garbage Collection Vehicles



Sewage Truck



Sewer Jetting Equipments



Combined Sewer Cleaning Equipments



Tipper



Water Tankers



Hook Lifts



Hydraulic Platforms



Fire Truck Parts



Special Equipments



Sewer Jetting and Cleaning Components





ROAD EQUIPMENT AND MACHINERIES

Also Spare Parts Original- OEM - OES





MINING , NATURAL STONE AND ENGINEERING APPLICATIONS and Machineries





CONSTRUCTION MACHINERIES & EQUIPMENT

Fastest , Safests, Largest After Market

Spare parts – Original, OEM and OES





CONSTRUCTION EQUIPMENT, MACHINES & VEHICLES

After Market & Spare Parts – Original , OEM & OES

More Than 35 Million USD stock in our Warehouses



- HYDRAULIC SYSTEM SPARE PARTS
- PALLET UNDERCARRIAGE TEAMS
- SEALING PARTS
- EXCAVATOR AND DRILLING NAIL-ADAPTER
- BUCKET AND NAIL MATERIALS
- COUPLING





CONSTRUCTION EQUIPMENT, MACHINES & VEHICLES

After Market & Spare Parts – Original , OEM & OES

More Than 35 Million USD stock in our Warehouses

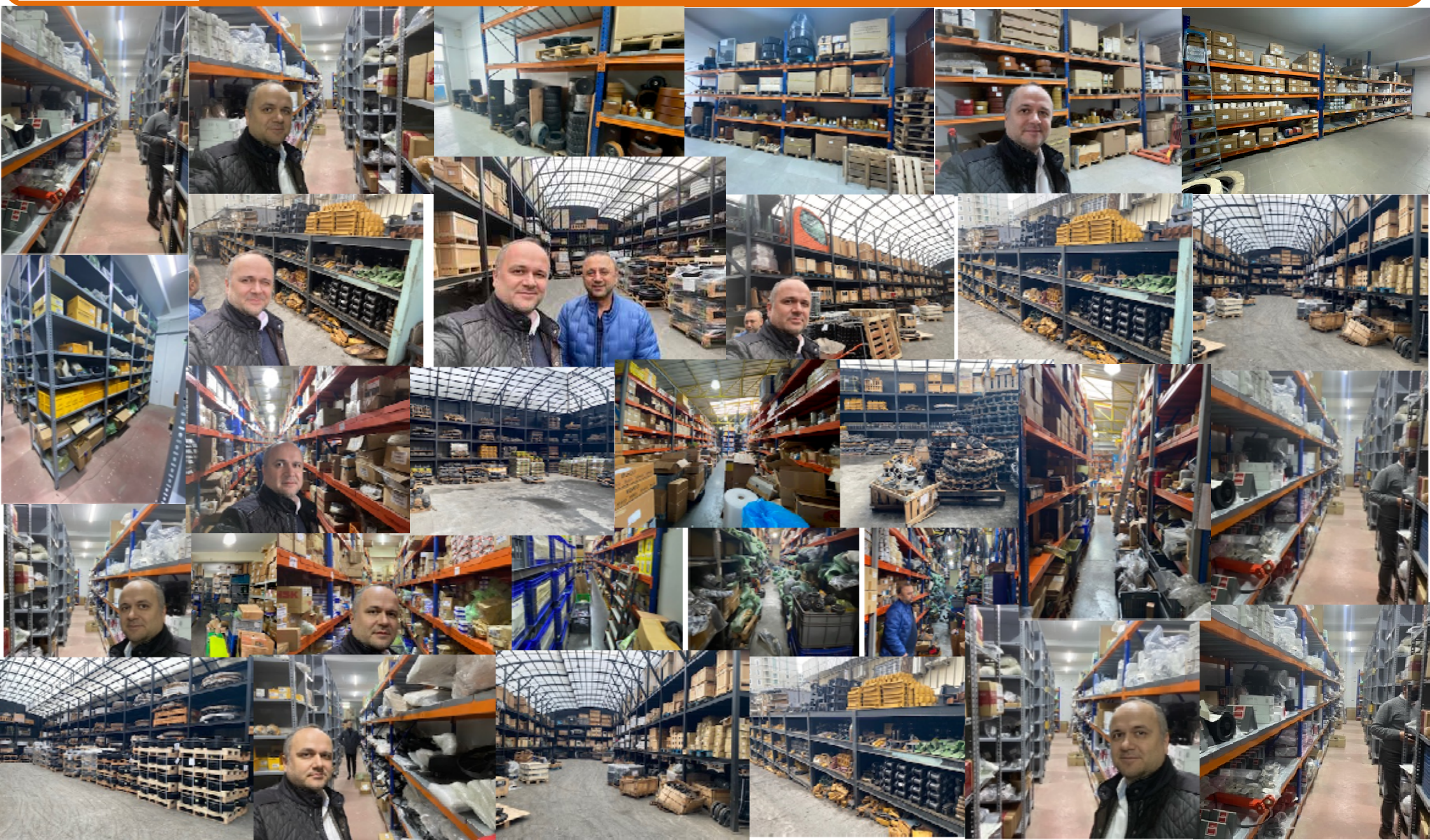



CONSTRUCTION EQUIPMENT, MACHINES & VEHICLES

After Market & Spare Parts – Original , OEM & OES

More Than 35 Million USD stock in our Warehouses



CATERPILLAR – KOMATSU – HITACHI -JCB – LIEBHERR

some of the parts which we are manufacturing in Türkiye



Тележки



Пальцы



Каретки, коромысла, крышки...



Ходовая



Группа Ободов



Резиновые детали



Балансирные балки



Группа соединительных узлов...



Группа гидравлики



Группа разных пальцев и вту...



Группа накладок (бронза)



Радиаторы



Группа пропеллеров



Маслоохладители



Коллекторы



Детали для двигателя



Детали Топливной Системы



Группа трансмиссии, турбин и...



CATERPILLAR – KOMATSU – HITACHI -JCB – LIEBHERR some of the parts which we are manufacturing in Türkiye



Группа масляных насосов



Шестерни



Группа глушителей



Группа воздушных компресс...



Тормозная группа



Фары и освещение



Остальные группы



Тележки



Пальцы



Каретки, коромысла, крышки..





CATERPILLAR – KOMATSU – HITACHI -JCB – LIEBHERR

some of the parts which we are manufacturing in Türkiye

MOTOR GRADER PARTS



BACKHOE LOADER PARTS



WHEEL LOADER PARTS



BRAKE GP & RIM



HYDRAULIC PARTS



TORQUE CONVERTOR PARTS



ENGINE PARTS

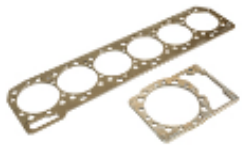

OIL COOLERS & RADIATORS



EXHAUST COMPONENTS



ARTICULATED TRUCK PARTS



PLANETARY TRANSMISSION PARTS

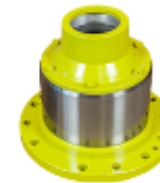

VARIOUS MANUFACTURING



TRACK TYPE TRACTOR PARTS



EXCAVATOR PARTS



TRACK LOADER PARTS



JOINT GP & YOKE









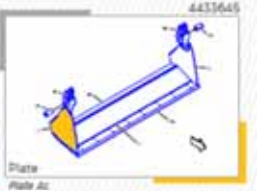
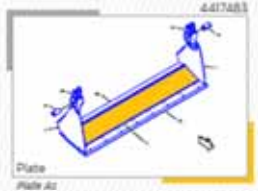
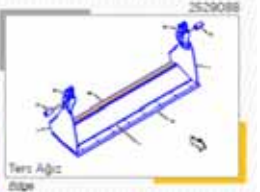
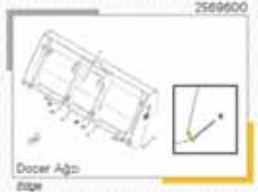
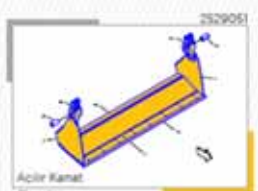
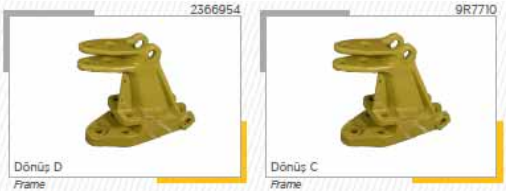







































CATERPILLAR – KOMATSU – HITACHI -JCB – LIEBHERR

some of the parts which we are manufacturing in Türkiye



CATERPILLAR – KOMATSU – VOLVO –JCB- CNH

Some of the Parts which we are Manufacturing

| | | | | | | | | | |
|---|--|---|---|---|--|--|--|--|---|
| <p>1302998</p>  <p>Aks Burcu İç Ön ZF Dif. Shing</p> | <p>1388530</p>  <p>Aks Burcu İç Ön ZF Dif. Shing</p> | <p>2145097</p>  <p>Direksiyon Silindiri Ön 428/432 Çilindir Gp-Steering Front Ax</p> | <p>3953475</p>  <p>Direksiyon Silindiri Arka 434/444 Çilindir Gp-Steering Rear Ax</p> | <p>1987820</p>  <p>Tas Bapı Kıp Top Kapesi Ön Alt 434/444 Seal</p> | <p>1987820</p>  <p>Tas Bapı Kıp Top Kapesi Arka Alt 434/444 Seal</p> | <p>2385236</p>  <p>Komple Rot Ön Arka Sağ 434/444 Tie Rod As (Rt)</p> | <p>2385237</p>  <p>Komple Rot Ön Arka Sol 434/444 Tie Rod As (Lh)</p> | | |
| <p>4852422</p>  <p>Aks İstavrozlu Ön 428/432 Kit-Spider</p> | <p>2198794</p>  <p>Aks İstavrozlu Ön 434/444 Kit-Spider</p> |  | | <p>197046</p>  <p>Tas Bapı Kıp Top Kapesi Ön Üst ZF Dif. Seal</p> | <p>197047</p>  <p>Tas Bapı Kıp Top Kapesi Ön Alt ZF Dif. Seal</p> | <p>2043080</p>  <p>Rotil Ön 428/432 Ball Joint</p> | <p>3161923</p>  <p>Rotil Ön Arka 434/444 Ball Joint</p> | | |
| <p>2264355</p>  <p>Aks İstavrozlu Arka 434/444 Kit-Spider</p> | <p>2264355</p>  <p>Aks İstavrozlu Ön ZF Dif. Kit-Spider</p> | | | <p>3N4968</p>  <p>Tas Bapı Bilyası Ön Alt Üst 428/432 Cone-Bearing</p> | <p>601734</p>  <p>Tas Bapı Bilyası Ön Alt Üst 428/432 Cup-Bearing</p> | <p>2105943</p>  <p>Porya Kapağı Ön 428/432 Carrier-Planetary</p> | <p>2161601</p>  <p>Porya Kapağı Ön Arka 434/444 Carrier</p> | | |
| <p>2264357</p>  <p>Aks Yokesi Arka (Karpuz) 434/444 Yöke</p> | <p>2385220</p>  <p>Aks Yokesi Ön (Karpuz) 434/444 Yöke</p> | | | <p>1987830</p>  <p>Tas Bapı Kipi Ön Alt Pin</p> | <p>1987830</p>  <p>Tas Bapı Kipi Ön Alt Üst 428/432 Pin</p> | <p>2170049</p>  <p>Tas Bapı Bilyası Ön Alt Cup-Bearing</p> | <p>1987825</p>  <p>Tas Bapı Bilyası Ön Üst 434/444 Cup-Bearing</p> | <p>2161600</p>  <p>Difransiyel Yokesi Arka 428/432 Disc-Brake</p> | <p>4431361</p>  <p>Taşıyıcı Porya Ön 428/432 Flange As</p> |
| <p>1388526</p>  <p>Aks Yokesi Ön (Karpuz) ZF Dif. Yöke</p> | <p>2164464</p>  <p>Difransiyel Yokesi Ön 428/432 Yöke</p> | | | <p>1987830</p>  <p>Tas Bapı Kipi Ön Üst ZF Dif. Pin</p> | <p>1307026</p>  <p>Tas Bapı Kipi Ön Alt ZF Dif. Pin</p> | <p>0310426</p>  <p>Tas Bapı Bilyası Ön Üst ZF Dif. Cup-Bearing</p> | <p>653051</p>  <p>Tas Bapı Bilyası Alt ZF Dif. Cup-Bearing</p> | <p>2161609</p>  <p>Taşıyıcı Porya Ön Arka Bijonlu 434/444 Flange Gp-Wheel</p> | <p>2161602</p>  <p>Taşıyıcı Porya Ön Arka 434/444 Flange</p> |
| <p>2198828</p>  <p>Difransiyel Yokesi Ön 434/444 Yöke</p> | <p>1307046</p>  <p>Difransiyel Yokesi ZF Dif. Yöke</p> | <p>1987825</p>  <p>Tas Bapı Kıp Top Kapesi Ön Alt Üst 428/432 Seal</p> | <p>1987825</p>  <p>Tas Bapı Kıp Top Kapesi Ön Alt 434/444 Seal</p> | <p>2099886</p>  <p>Komple Rot Ön Sağ Sol 428/432 Tie Rod Gp</p> | <p>1303809</p>  <p>Komple Rot Ön ZF Dif. Tie Rod Gp</p> | <p>2264372</p>  <p>Housing Arka Sağ 434/444 Housing (Rt)</p> | <p>2167481</p>  <p>Housing Arka Sol 434/444 Housing (Lh)</p> | | |

CATERPILLAR – KOMATSU – VOLVO –JCB- CNH

Some of the Parts which we are Manufacturing



CATERPILLAR – KOMATSU – VOLVO –JCB- CNH

Some of the Parts which we are Manufacturing

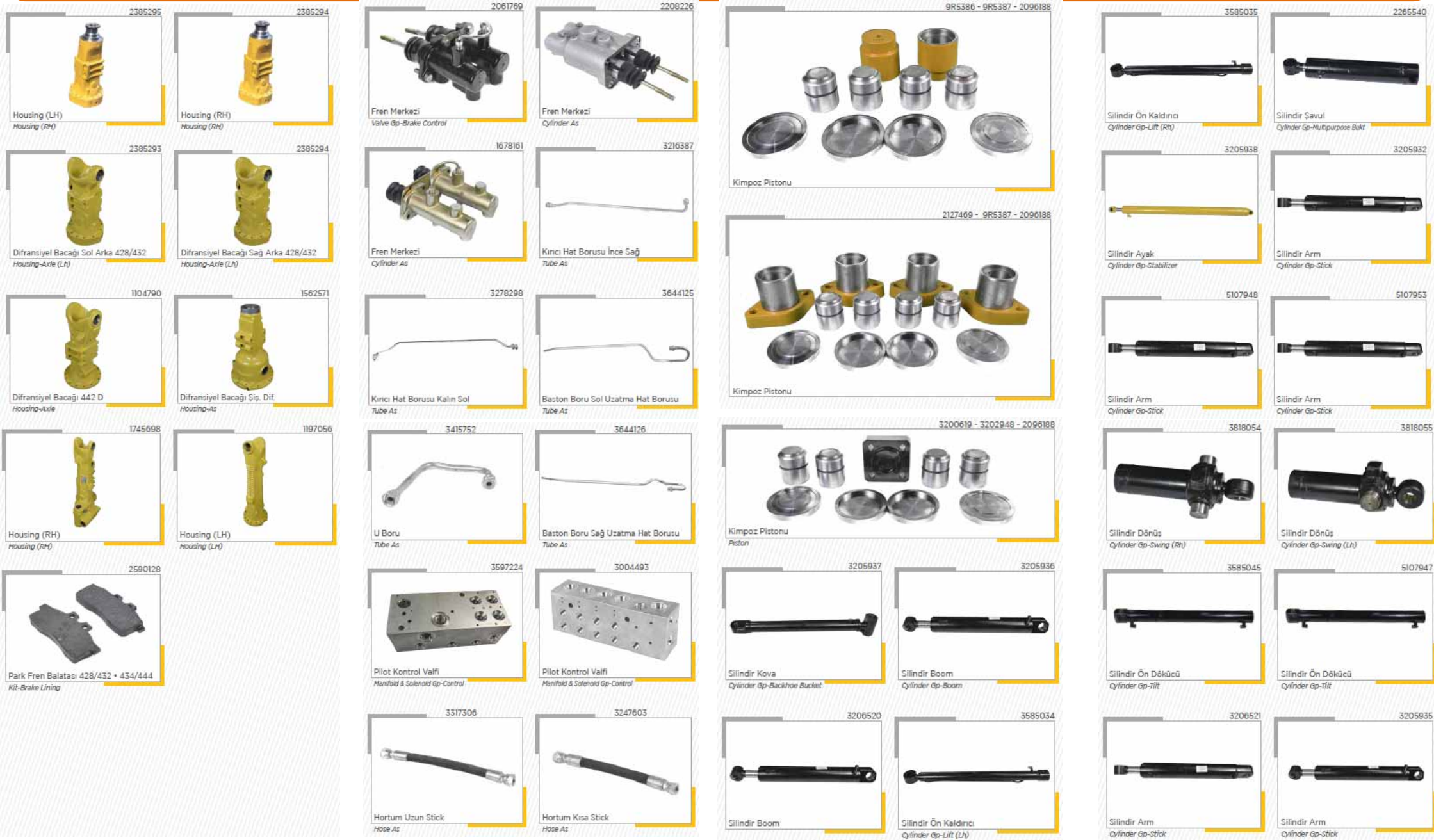





































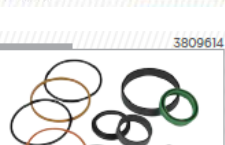
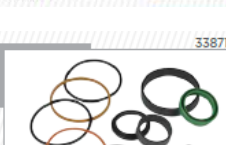





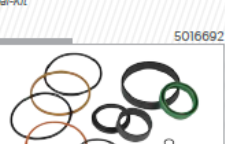



CATERPILLAR – KOMATSU – VOLVO –JCB- CNH

Some of the Parts which we are Manufacturing

| | | | | | | | | |
|---|---|---|---|---|---|--|---|---|
| <p>3205934 Silindir Ön Kaldırıcı Cylinder sp-Lift (Rh)</p> | <p>3519352 Silindir Ön Kaldırıcı Cylinder sp-Lift (LH)</p> | <p>3240411 Ön Devirici Lift Keçe Kiti Seal-Kit</p> | <p>5212973 Ön Devirici Lift Keçe Kiti Seal-Kit</p> | <p>7X2820 Ayak Lift Keçe Kiti Seal-Kit</p> | <p>5016692 Ayak Lift Keçe Kiti Seal-Kit</p> | <p>3240398 Boom Lift Keçe Kiti Seal-Kit</p> | <p>5016695 Boom Lift Keçe Kiti Seal-Kit</p> | |
| <p>3748059 Silindir Ön Kaldırıcı Cylinder sp-Lift (LH)</p> | <p>3748060 Silindir Ön Kaldırıcı Cylinder sp-Lift (Rh)</p> | <p>2265540 Savul Silindir Cylinder sp-Multipurpose Buik</p> | <p>4373547 Ön Devirici Lift Keçe Kiti Seal-Kit</p> | <p>2281778 Ön Ana Bom Kaldırıcı Lift Keçe Kiti Seal-Kit</p> | <p>2925424 Yengeç Lift Keçe Kiti Seal-Kit</p> | <p>444-9004 Yengeç Lift Keçe Kiti Seal-Kit</p> | <p>5016706 Boom Lift Keçe Kiti Seal-Kit</p> | <p>3240397 Boom Lift Keçe Kiti Seal-Kit</p> |
| <p>3053570 Bom Üstü Kinciri Geri Dönüş Hat Borusu Tube As</p> | <p>3053571 Bom Üstü Kinciri Geri Dönüş Hat Borusu Tube As</p> | <p>2600273 Ön Ana Bom Kaldırıcı Lift Keçe Kiti Seal-Kit</p> | <p>3790117 Ön Ana Bom Kaldırıcı Lift Keçe Kiti Seal-Kit</p> | <p>2409538 Dönüş Lift Keçe Kiti Seal-Kit</p> | <p>2332622 Dönüş Lift Keçe Kiti Seal-Kit</p> | <p>5016704 Boom Lift Keçe Kiti Seal-Kit</p> | <p>2959891 Boom Lift Keçe Kiti Seal-Kit</p> | |
| <p>1856583 Savul Lift Keçe Kiti Seal-Kit</p> | <p>2350354 Savul Lift Keçe Kiti Seal-Kit</p> | <p>3240356 Ön Ana Bom Kaldırıcı Lift Keçe Kiti Seal-Kit</p> | <p>5016702 Ön Ana Bom Kaldırıcı Lift Keçe Kiti Seal-Kit</p> | <p>3779352 Dönüş Lift Keçe Kiti Seal-Kit</p> | <p>2418924 Boom Lift Keçe Kiti Seal-Kit</p> | <p>5016695 Arm Lift Keçe Kiti Seal-Kit</p> | <p>5016706 Arm Lift Keçe Kiti Seal-Kit</p> | |
| <p>2309357 Savul Lift Keçe Kiti Seal-Kit</p> | <p>7X2760 Ön Devirici Lift Keçe Kiti Seal-Kit</p> | <p>4388721 Ön Ana Bom Kaldırıcı Lift Keçe Kiti Seal-Kit</p> | <p>1787189 Direksiyon Lift Keçe Kiti Seal-Kit</p> | <p>2350973 Boom Lift Keçe Kiti Seal-Kit</p> | <p>2959893 Boom Lift Keçe Kiti Seal-Kit</p> | <p>3240397 Arm Lift Keçe Kiti Seal-Kit</p> | <p>3240398 Arm Lift Keçe Kiti Seal-Kit</p> | |
| <p>2384462 Ön Devirici Lift Keçe Kiti Seal-Kit</p> | <p>2617175 Ön Devirici Lift Keçe Kiti Seal-Kit</p> | <p>2152023 Direksiyon Lift Keçe Kiti Seal-Kit</p> | <p>2807013 Direksiyon Lift Keçe Kiti Seal-Kit</p> | <p>3812732 Boom Lift Keçe Kiti Seal-Kit</p> | <p>3975704 Boom Lift Keçe Kiti Seal-Kit</p> | <p>5016704 Arm Lift Keçe Kiti Seal-Kit</p> | <p>3809470 Arm Lift Keçe Kiti Seal-Kit</p> | |

CATERPILLAR – KOMATSU – VOLVO –JCB- CNH

Some of the Parts which we are Manufacturing

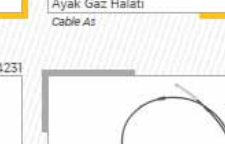
| | | | | | | | |
|---|---|---|--|---|---|--|--|
| <p>1864327</p>  <p>Kova Lift Keçe Kiti Seal-Kit</p> | <p>1945603</p>  <p>Kova Lift Keçe Kiti Seal-Kit</p> | <p>2690388</p>  <p>Dönüş Kovan Somunu Ince Diş Head</p> | <p>2132483</p>  <p>Kova Kovan Somunu Head</p> | <p>3199513</p>  <p>Direksiyon Amortisörü E.M Spring As-Gas</p> | <p>3381508</p>  <p>Direksiyon Amortisörü Spring Gp-Gas</p> | <p>2319364</p>  <p>Motor Yan Kapak Rh Enclosure As (Rh)</p> | <p>2441085</p>  <p>Motor Yan Kapak Lh Enclosure (Lh)</p> |
| <p>4158260</p>  <p>Kova Lift Keçe Kiti Seal-Kit</p> | <p>3651283</p>  <p>Kova Lift Keçe Kiti Seal-Kit</p> | <p>3364179</p>  <p>Kova İç Keçe Yatağı Piston</p> | <p>2332583</p>  <p>Dönüş İç Keçe Yatağı Piston</p> | <p>4334269</p>  <p>Direksiyon Amortisörü F2 Kit-Gas Spring</p> | <p>1594269</p>  <p>Kapi Amortisörü Spring Gp-Gas</p> | <p>3177315</p>  <p>Motor Yan Kapak Rh Enclosure As (Rh)</p> | <p>3177180</p>  <p>Motor Yan Kapak Lh Enclosure As (Lh)</p> |
| <p>3240386</p>  <p>Kova Lift Keçe Kiti Seal-Kit Ear</p> | <p>5212974</p>  <p>Kova Lift Keçe Kiti Seal-Kit</p> | <p>2332595</p>  <p>Dönüş Kovan Somunu Kalın Diş Head As</p> | <p>1488439</p>  <p>T Rekor Sıkma Kimpoz Tee As</p> | <p>4248681</p>  <p>Kapi Amortisörü F2 Spring Gp-Gas</p> | <p>4990734</p>  <p>Kapi Amortisörü Spring Gp-Gas</p> | <p>1454476</p>  <p>Motor Yan Kapak Rh Enclosure As</p> | <p>1454476</p>  <p>Motor Yan Kapak Lh Enclosure As</p> |
| <p>3809614</p>  <p>Uzatma Lift Keçe Kiti Seal-Kit</p> | <p>3387156</p>  <p>Uzatma Lift Keçe Kiti Seal-Kit</p> | <p>1438378</p>  <p>L Rekor Sıkma Kimpoz Ve Savul Elbow As</p> | <p>3611727</p>  <p>Şanzıman Yağ Borusu Y.M Kısa Tip Flange As</p> | <p>1641328</p>  <p>Arka Cam Amortisörü Spring As-Gas</p> | <p>3151311</p>  <p>Arka Cam Amortisörü Spring-Gas</p> | <p>2093366</p>  <p>El Gaz Halatı Cable As</p> | <p>2323072</p>  <p>Ayak Halatı Cable As</p> |
| <p>5016692</p>  <p>Uzatma Lift Keçe Kiti Seal-Kit</p> | <p>9T4008</p>  <p>Savul Mili E.M Rod As</p> | <p>2143745</p>  <p>Şanzıman Yağ Borusu Y.M Tube As</p> | <p>1387380</p>  <p>Şanzıman Yağ Borusu E.M Tube As</p> | <p>4386971</p>  <p>Arka Cam Amortisörü Spring As-Gas</p> | <p>4184037</p>  <p>Panjur Amortisörü Spring As-Gas</p> | <p>3314357</p>  <p>Ayak Halatı Cable As</p> | <p>2350128</p>  <p>Ayak Gaz Halatı Cable As</p> |
| <p>2332631</p>  <p>Savul Mili Y.M Rod As</p> | <p>2332631</p>  <p>Dönüş Mili Rod As</p> | <p>2278807</p>  <p>Fren Tüpü Akümülatör Accumulator Gp-Hydraulic</p> | <p>1667870</p>  <p>Pad</p> | <p>2549301</p>  <p>Kapot Amortisörü Spring As-Gas</p> | <p>3632867</p>  <p>Kapot Amortisörü Spring As-Gas</p> | <p>3034231</p>  <p>Bom Kilit Halatı Cable As</p> | <p>3103933</p>  <p>Bom Kilit Halatı Cable As</p> |

CATERPILLAR – KOMATSU – VOLVO –JCB- CNH

Some of the Parts which we are Manufacturing

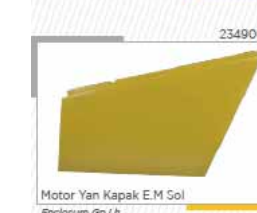
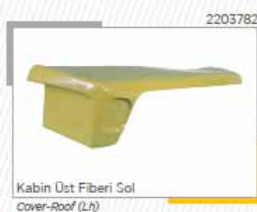
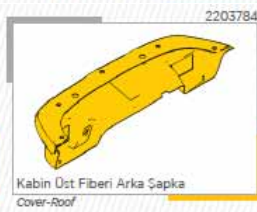
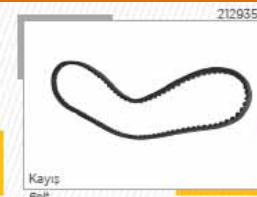

CATERPILLAR – KOMATSU – VOLVO –JCB- CNH

Some of the Parts which we are Manufacturing



CATERPILLAR – KOMATSU – VOLVO –JCB- CNH

Some of the Parts which we are Manufacturing

9T0973



Hidrolik Filtresi E Serisi

3621163



Hidrolik Filtresi F Serisi



4717003



Sanjiman Filtresi E/F Serisi

7W2326



Motor Yağ Filtresi E/F Serisi



4T78134



Kabin Filtresi Dış F Serisi

2112661



Kabin Filtresi Dış E Serisi



2112660



Kabin Filtresi İç E/F Serisi

3491063



Transfer Pompası E/F Serisi



3610554



Yakıt Filtresi E/F Serisi Kısa

3610554



Yakıt Filtresi E/F Serisi Uzun

| SIRA NO | ÜRÜN KODU | ÜRÜN ADI |
|---------|-----------|----------|
| 1 | 101-4020 | PIN AS |
| 2 | 111-4334 | PIN |
| 3 | 111-4340 | PIN |
| 4 | 111-4341 | PIN |
| 5 | 111-4342 | PIN |
| 6 | 111-4343 | PIN |
| 7 | 114-3836 | PIN |
| 8 | 118-1348 | PIN |
| 9 | 122-4954 | PIN AS |
| 10 | 125-1037 | PIN AS |
| 11 | 130-0484 | PIN |
| 12 | 130-1918 | PIN AS |
| 13 | 130-5451 | PIN |
| 14 | 154-5277 | PIN |
| 15 | 154-5278 | PIN |
| 16 | 154-5279 | PIN |
| 17 | 154-5280 | PIN |
| 18 | 159-0960 | PIN AS |
| 19 | 159-0961 | PIN |
| 20 | 173-2769 | PIN |
| 21 | 173-7758 | PIN |
| 22 | 184-1413 | PIN AS |
| 23 | 184-9956 | PIN |
| 24 | 209-6850 | PIN AS |
| 25 | 209-6855 | PIN |
| 26 | 213-6693 | PIN |
| 27 | 213-6695 | PIN |
| 28 | 213-6698 | PIN |
| 29 | 214-6143 | PIN |
| 30 | 215-9448 | PIN AS |
| 31 | 216-8483 | PIN |
| 32 | 216-8484 | PIN |
| 33 | 216-8485 | PIN |
| 34 | 216-8486 | PIN |
| 35 | 216-8488 | PIN |
| 36 | 216-8489 | PIN AS |
| 37 | 216-8492 | PIN |
| 38 | 216-8493 | PIN |
| 39 | 216-8494 | PIN |
| 40 | 216-8495 | PIN |
| 41 | 216-8496 | PIN AS |
| 42 | 217-0055 | PIN |
| 43 | 220-1018 | PIN |
| 44 | 220-1019 | PIN |
| 45 | 236-8182 | PIN |
| 46 | 237-5330 | PIN |
| 47 | 247-7631 | PIN AS |
| 48 | 300-5440 | PIN |
| 49 | 308-4665 | PIN |
| 50 | 310-0843 | PIN AS |
| 51 | 310-0851 | PIN |
| 52 | 316-6945 | PIN |
| 53 | 316-6946 | PIN AS |
| 54 | 316-6947 | PIN |
| 55 | 316-6948 | PIN |
| 56 | 316-6949 | PIN |
| 57 | 316-6951 | PIN AS |
| 58 | 316-6952 | PIN AS |

| SIRA NO | ÜRÜN KODU | ÜRÜN ADI |
|---------|-----------|---------------|
| 59 | 317-4928 | PIN AS |
| 60 | 320-9164 | PIN |
| 61 | 320-9341 | PIN |
| 62 | 322-4583 | PIN |
| 63 | 322-4584 | PIN |
| 64 | 322-4585 | PIN |
| 65 | 322-4586 | PIN |
| 66 | 322-4587 | PIN |
| 67 | 322-4589 | PIN |
| 68 | 325-2009 | PIN |
| 69 | 326-0088 | PIN |
| 70 | 326-0089 | PIN AS |
| 71 | 326-0093 | PIN AS |
| 72 | 328-5234 | PIN |
| 73 | 330-9669 | PIN |
| 74 | 330-9673 | PIN |
| 75 | 330-9676 | PIN |
| 76 | 330-9677 | PIN |
| 77 | 330-9678 | PIN |
| 78 | 330-9679 | PIN AS |
| 79 | 330-9680 | PIN |
| 80 | 330-9681 | PIN |
| 81 | 330-9682 | PIN |
| 82 | 330-9683 | PIN |
| 83 | 330-9684 | PIN |
| 84 | 333-4757 | PIN AS |
| 85 | 334-4169 | LOCKPIN |
| 86 | 341-6152 | PIN |
| 87 | 344-2567 | PIN AS |
| 88 | 360-2813 | PIN |
| 89 | 360-2814 | PIN |
| 90 | 360-2815 | PIN |
| 91 | 360-2816 | PIN |
| 92 | 372-5085 | PIN AS |
| 93 | 380-2565 | PIN |
| 94 | 380-2566 | PIN |
| 95 | 380-2566 | PIN |
| 96 | 380-2567 | PIN |
| 97 | 380-2569 | PIN |
| 98 | 380-2570 | PIN AS |
| 99 | 380-2571 | PIN |
| 100 | 380-2767 | PIN |
| 101 | 384-5429 | PIN |
| 102 | 385-0579 | PIN-BOOM LOCK |
| 103 | 386-3778 | PIN AS |
| 104 | 425-1825 | PIN AS |
| 105 | 438-0593 | PIN |
| 106 | 9R-2958 | PIN |
| 107 | 9R-4676 | PIN |
| 108 | 9R-4677 | PIN |
| 109 | 9R-4678 | PIN |
| 110 | 9R-6163 | PIN |
| 111 | 9R-6785 | PIN |
| 112 | 9R-8523 | PIN |
| 113 | 9R-8594 | PIN AS |
| 114 | 9R-9105 | PIN AS |
| 115 | 9R-9812 | PIN |

CATERPILLAR – KOMATSU – VOLVO –JCB- CNH

Some of the Parts which we are Manufacturing

BURÇ

| SIRA NO | ÜRÜN KODU | ÜRÜN ADI | SIRA NO | ÜRÜN KODU | ÜRÜN ADI |
|---------|-----------|----------|---------|-----------|------------------|
| 1 | 102-4560 | BUSHING | 26 | 331-1521 | BEARING |
| 2 | 08-4825 | BUSHING | 27 | 331-1522 | BEARING |
| 3 | 209-6181 | BUSHING | 28 | 362-5004 | BUSHING |
| 4 | 212-8960 | BEARING | 29 | 3T-4307 | BUSHING |
| 5 | 213-6682 | BUSHING | 30 | 9R-0111 | BUSHING |
| 6 | 213-6683 | BUSHING | 31 | 9R-0139 | BUSHING |
| 7 | 213-6687 | BUSHING | 32 | 9R-0147 | BUSHING |
| 8 | 213-6702 | BUSHING | 33 | 9R-0153 | BUSHING |
| 9 | 213-6703 | BEARING | 34 | 9R-0162 | BUSHING |
| 10 | 213-6719 | BUSHING | 35 | 9R-0170 | BUSHING |
| 11 | 215-1906 | BUSHING | 36 | 9R-0321 | BUSHING |
| 12 | 220-1012 | BUSHING | 37 | 9R-0411 | BUSHING |
| 13 | 223-0198 | BUSHING | 38 | 9R-0413 | BUSHING |
| 14 | 236-8183 | BUSHING | 39 | 9R-1496 | BUSHING |
| 15 | 237-0944 | BUSHING | 40 | 9R-3092 | BUSHING |
| 16 | 237-0945 | BUSHING | 41 | 9R-3700 | BUSHING |
| 17 | 237-2252 | BUSHING | 42 | 9R-4710 | BUSHING |
| 18 | 262-7043 | BEARING | 43 | 9R-4602 | BUSHING |
| 19 | 262-7044 | BEARING | 44 | 9R-4675 | BUSHING-TERMINAL |
| 20 | 274-4274 | BUSHING | 45 | 9R-6690 | BUSHING |
| 21 | 278-5454 | BUSHING | 46 | 9R-7215 | BEARING |
| 22 | 278-7695 | BUSHING | 47 | 9R-7691 | BUSHING |
| 23 | 286-7166 | BUSHING | 48 | 9T-2683 | BEARING |
| 24 | 326-3362 | BUSHING | 49 | 9T-4007 | BEARING |
| 25 | 331-1520 | BEARING | | | |

RADYATÖRLER

1403634



Radyatör
Radiator AS

2144740



Radyatör
Radiator GP

2105948



Radyatör
Radiator GP

3047851



Radyatör
Radiator GP

2144746



Radyatör
Core As-Oil Cooler
(Hydraulic)

2144747



Radyatör
Core As-Oil Cooler
(Transmission)

CATERPILLAR – KOMATSU – VOLVO –JCB- CNH

Some of the Parts which we are Manufacturing

RADYATÖRLER

2105953



Radyatör
Cooler As-Oil-Hydraulic, Transmission

3775265



Radyatör
Cooler Gp-Oil (Hydraulic)

3775264



Radyatör
Aftercooler Gp-Air

3599885



Radyatör
Condenser As

1423391



Pervane
Spider As 9-Blade



Grid of various small parts including rollers, pulleys, and seals.

1956345



Jant
Wheel As (Rear, Rh)

9R3545



Jant
Rim (Front)

2026186



Jant
Wheel As (Front)

4626421



Jant
Wheel As

1131150



Saft Arka
Shaft As-Main

3043269



Saft Arka
Shaft As (Rear)

3590372



Saft Arka
Shaft As

2027875



Saft Ön 92 Cm
Shaft As-Front

3043266



Saft Ön 95 Cm
Shaft As (Front)

3590381



Saft Ön 98 Cm
Shaft As

5V2545



Saft Kepi
Strap

1076826



Keç Cıvatası
Bolt (5/16-24X0.75-In)

SANZIMAN

6Y7929

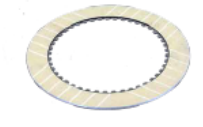

Balata
Disc-Friction

1217385



Pompa
Pump Gp-Transmission

2744553



Sac
Disc-Clutch

3373530

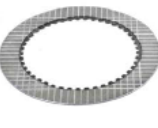

İnce Balata
Disc-Friction

3934195



Conta Seti

2807012



Bobin
Solenoid As

1226787



Yoke
Yoke As

3809030



Bobin
Valve Gp-Solenoid (12-Volt) (All Wheel Drive)





JCB SPARE PARTS –ORIGINAL –OEM -OES

Some of the Parts which we are Manufacturing

PRODUCTION CATEGORIES →

SPARE PARTS CATEGORIES →



Shafts



Pins

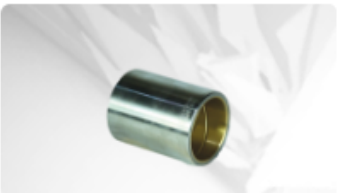

Bushes



Bodyworks



Transmission



Shaft



Front Axle



Rear Axle



Transmission



Wheel



Brake



Engine



Attachments



Cylinder



Pipe



Filters



Electrical Components



Bearings



JCB SPARE PARTS –ORIGINAL –OEM -OES

Some of the Parts which we are Manufacturing



Pins



Buckets



Elements Of Control



Hydraulic



Glass



Rear Axle



Front Axle



Cab



Loader



Backhoe



Bushes



Rubber based spare parts manufacturing in TÜRKIYE

AMMANN



BITELLI

BOMAG



CATERPILLAR



DOOSAN



HİDROMEK

HITACHI



KOBELCO

KOMATSU

LIEBHERR

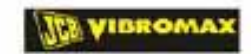

TAMROCK

VOLVO



DIESEL ENGINES

- Cummins Diesel Engine
- Komatsu Diesel Engine
- Daewoo Diesel Engine
- Isuzu Diesel Engine
- Hino Diesel Engine
- Doosan Diesel Engine
- Mitsubishi Diesel Engine
- Hyundai Diesel Engine
- Iveco Diesel Engine
- Yanmar Diesel Engine
- Perkins Diesel Engine
- Nissan Diesel Engine
- Caterpillar Diesel Engine
- Deutz Engine
- Volvo Engines
- Izumi Engine Spares
- Mc Bee Cummins and Caterpillar Engine Spares



DIESEL ENGINES – KOMATSU & DOOSAN

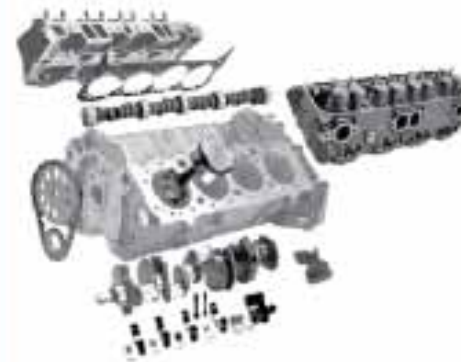
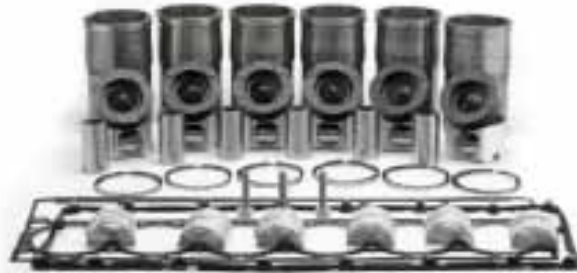

DIESEL ENGINES – MITSUBISHI & ISUZU



DIESEL ENGINES – HINO & HYUNDAI

HINO DİZEL MOTOR

Tüm Hino Dizel motor ve yakıt sistem parçaları mevcuttur.



HYUNDAI DİZEL MOTOR

Tüm Hyundai Dizel motor ve yakıt sistem parçaları mevcuttur.

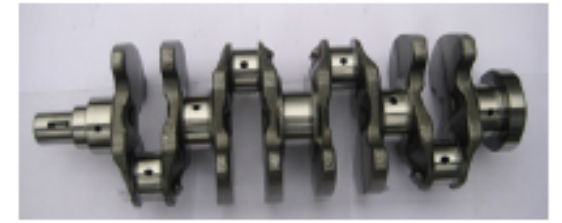
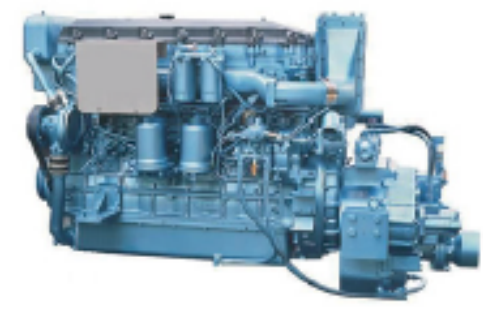

IVECO DİZEL MOTOR

Tüm Iveco Dizel motor ve yakıt sistem parçaları mevcuttur.

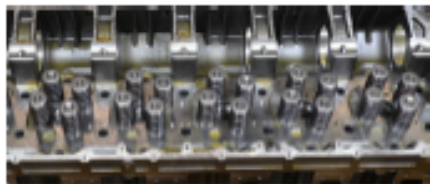

YANMAR DİZEL MOTOR

Tüm Yanmar Dizel motor ve yakıt sistem parçaları mevcuttur.



CATERPILLAR DİZEL MOTOR

Tüm Caterpillar Dizel motor ve yakıt sistem parçaları mevcuttur.

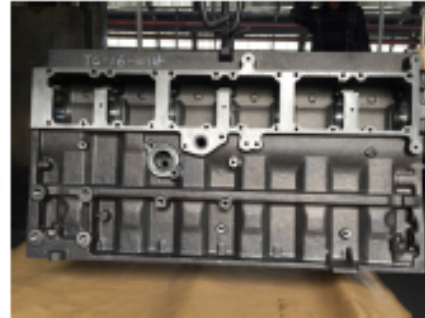

PERKINS DİZEL MOTOR

Tüm Perkins Dizel motor ve yakıt sistem parçaları mevcuttur.



DEUTZ DİZEL MOTOR

Tüm Deutz DİZEL motor ve yakıt sistem parçaları mevcuttur.



DEUTZ Motor Yedek Parçaları

IZUMI DİZEL MOTOR

Tüm Izumi DİZEL motor ve yakıt sistem parçaları mevcuttur.



MAHLE[®]
ORIGINAL

HYDRAULIC SYSTEM PARTS

SPV / SPK CAT Series

SPV / SPK Series

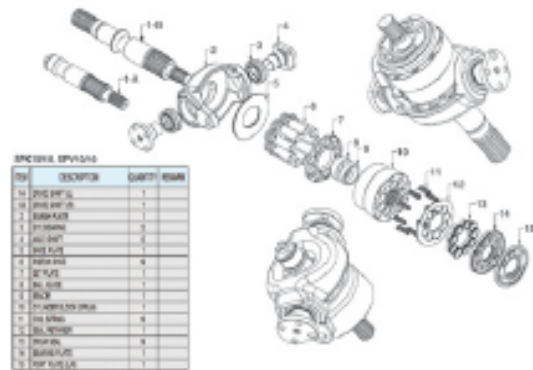

MAG KAYABA Series

MAG Series

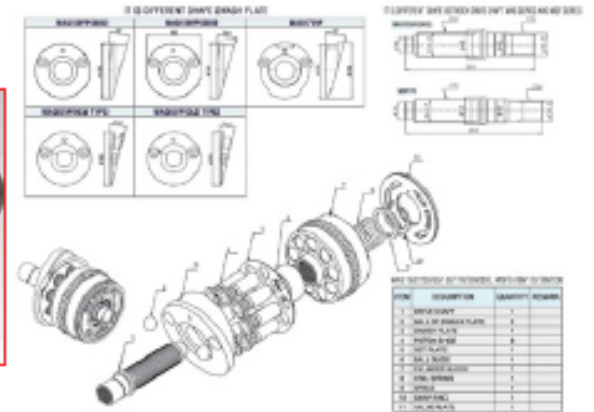

SG TOSHIBA Series

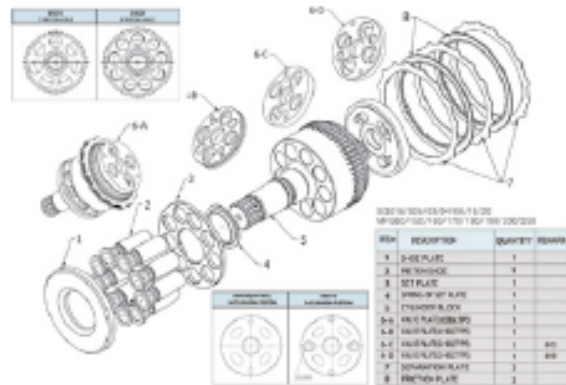

SG TOSHIBA

K3V Series

K3V 63, 112, 140, 180, 200, 280DT/P
K5V 80, 140, 160, 200DT/P
K7V 63DT/P

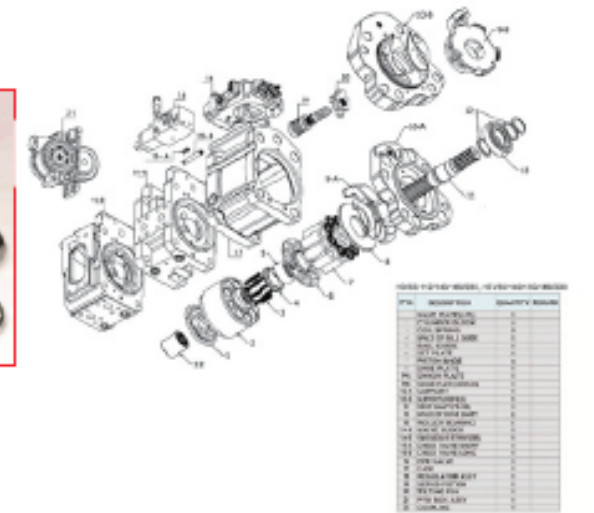

K3V Series

A2F Series

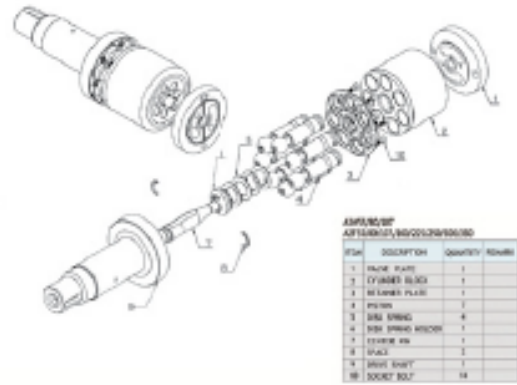

A2F Series



SBS Series

SBS Series

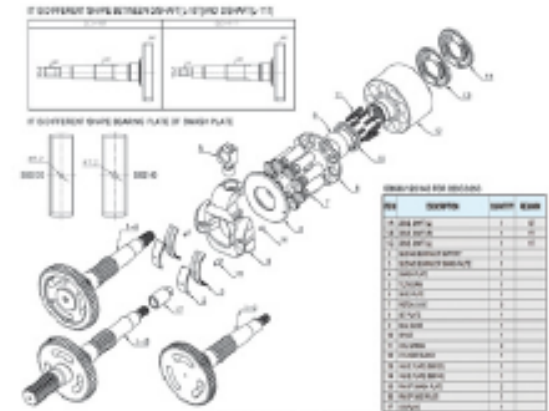

A8V Series

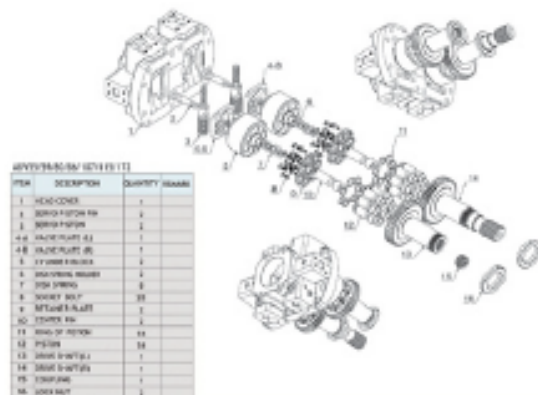

A8V Series



GM Series

GM Series

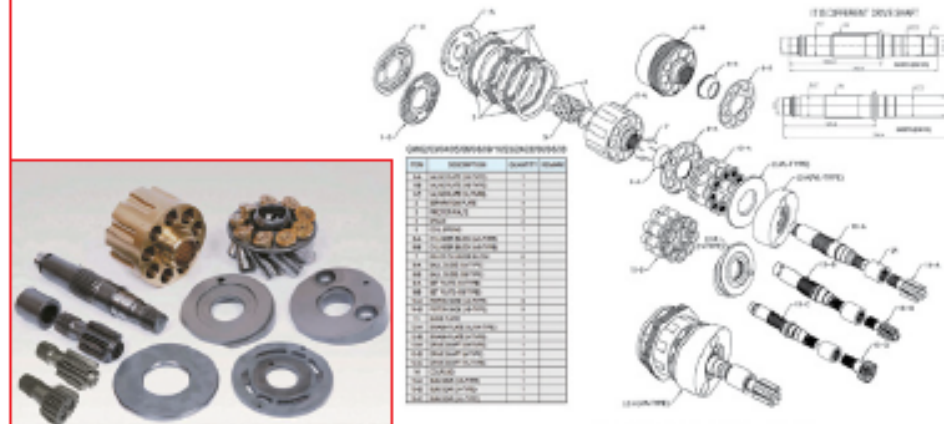

HYDRAULIC SYSTEM PARTS

Kule Şanzıman ve Yedekleri

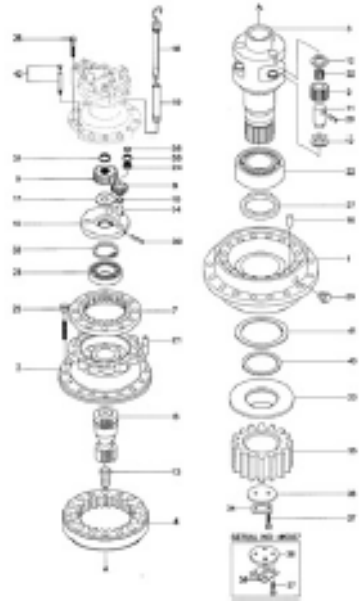
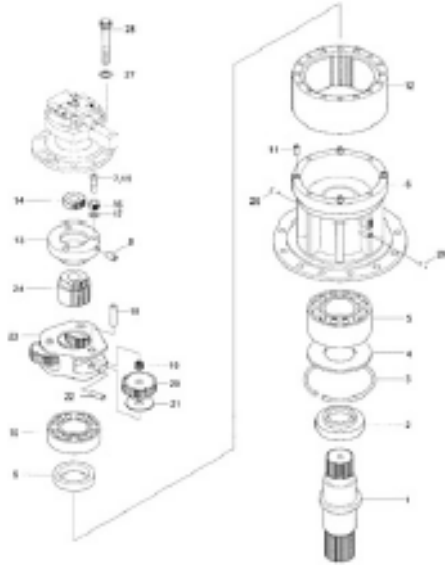

Kule Şanzıman ve Yedekleri

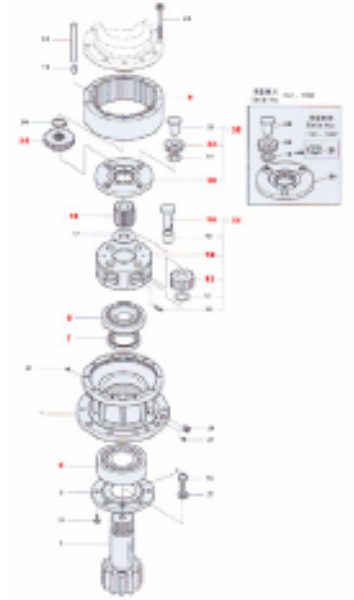

HYDRAULIC SYSTEM PARTS

Kule Dişlisi ve Pinion Dişlisi



Kule Hidrolik Pompası
Regülatör
Kule Dönüş Motoru



CONSTRUCTION MACHINERY UNDERCARRIAGES



İstikamet Tekerleri
Çer Rimleri
Yürüyüş Makaraları
Taşıyıcı Makaralar
İstikamet Çataları
Palet Gergil Yayıları
Palet Gergil Sistemi Komple
Palet Pabuçları
Palet Cıvata Ve Somunları
Şase Makaraları&Rim Cıvata+Somun

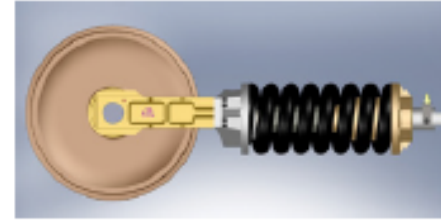

CONSTRUCTION MACHINERY UNDERCARRIAGES

- Dozer Yürüyüş Makaraları
- Dozer Taşıyıcı Makaraları
- Dozer Rim Dışlıları
- Dozer İstikamet Tekerleri
- Dozer Palet Pabuçları
- Dozer Zincirleri
- Dozer Paletleri Komple
- Palet Gergil Grassörlükleri

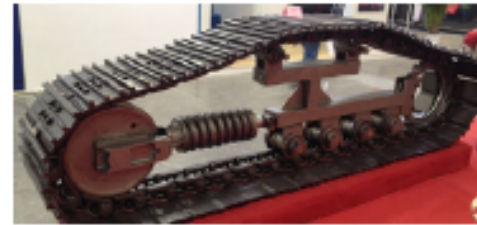

SEALING SPARE PARTS



- Lift Keçe Tamir Takımları
- Boom Lift Keçe Tamir Takımları
- Arın Lift Keçe Tamir Takımları
- Kova Lift Keçe Tamir Takımları
- Hidrolik Ana Pompa Keçe Ve Tamir Takımları
- Ana Kontrol Valf Tamir Takımları
- Yürüyüş Hidromotor Tamir Takımları
- Plot Levye Tamir Takımları
- Direksiyon Silindri Keçe Tamir Takımları
- Dökücü Lift Keçe Tamir Takımları
- Palet Gergi Keçe Tamir Takımları
- Kule Hidromotor Tamir Takımları
- Cer Life Time Keçeler
- Kule Şanzuman Keçeler
- Hidromotor Şaft Keçesi
- Hidrolik Ana Pompa Şaft Keçesi
- Yürüyüş Hidromotor Şaft Keçesi
- Ön Krank Keçesi
- Arka Krank Keçesi
- O-Ring Kutuları Tüm Ekavatörlere Ait
- Toz Keçeleri
- Kova Pim O-Ringleri



Direksiyon Silindir Keçe Tamir Takımları
Dökücü Lift Keçe Tamir Takımları
Palet Gergi Keçe Tamir Takımları
Kule Hidromotor Tamir Takımları
Cer Life Time Keçeleri
Kule Şanzıman Keçeleri
Hidromotor Şaft Keçesi
Hidrolik Ana Pompa Şaft Keçesi
Yürüyüş Hidromotor Şaft Keçesi
Ön Krank Keçesi
Arka Krank Keçesi
O-Ring Kutuları Tüm Etkavatörlere Ait
Toz Keçeleri
Kova Pim O-Ringleri





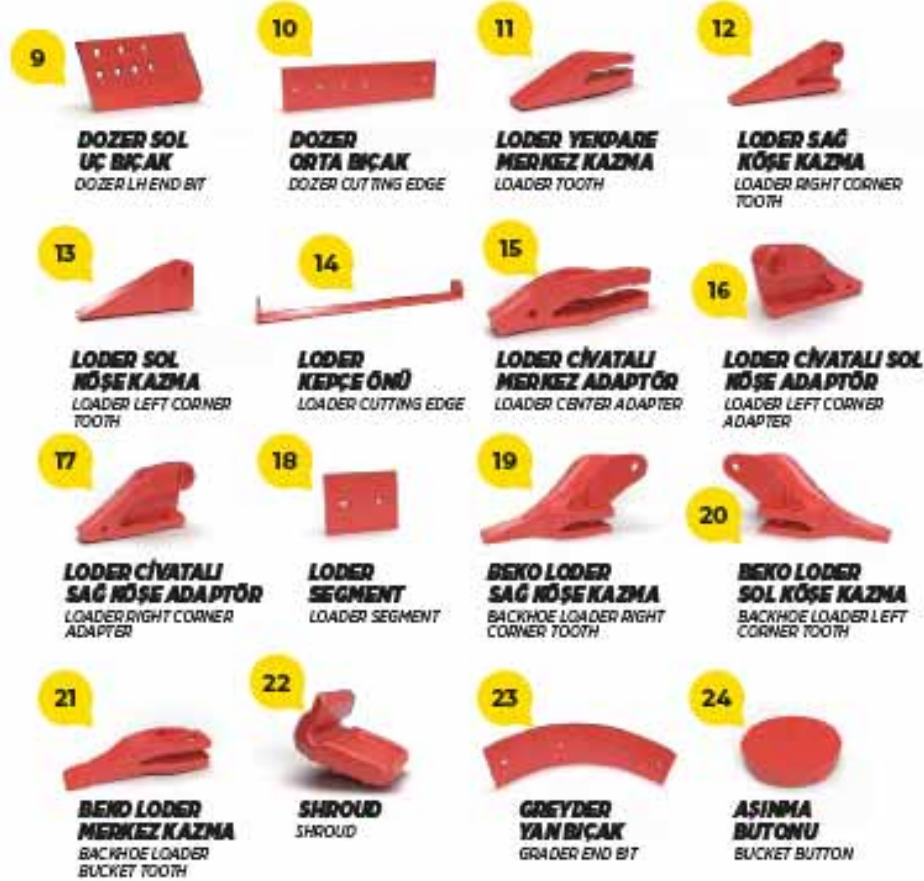
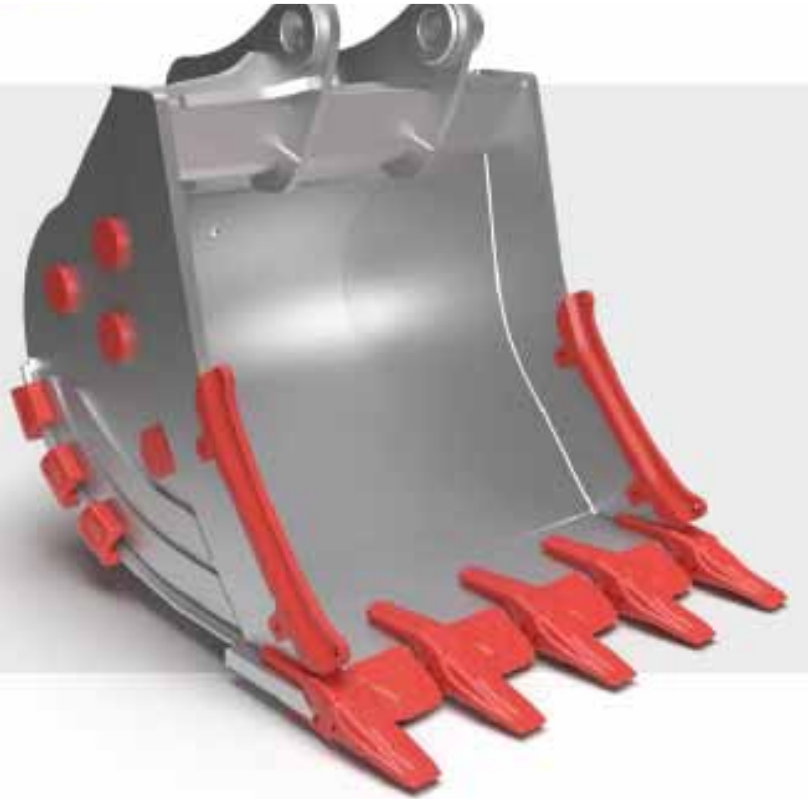

CAT

KOMATSU

FIAT HITACHI

HITACHI

LIEBHERR

KOBELCO

KAWASAKI

SAMSUNG

VOLVO

DAEWOO

HYUNDAI

HİDROMEK

CASE

EDER

SUMITOMO

FURUKAWA

XCMG

JCB

MASTAŞ

FERMEC

MASSEY FERGUSON

ÇUKUROVA

FAI

VENIERI

ESCO SUPER V SERIES

MITSUBISHI

CHAMPION

JOHN DEERE

NEW HOLLAND

DRESSER

EKSKAVATÖR

SF

ENK



Yüksek Performans
High performance



Uzun Çalışma Ömrü
Long service lifetime



Yüksek Dalıcılık
High submergibility



ENK SERIES



CX SERIES



SF SERIES



HYDRAULIC BREAKER HAMMER PARTS

- Altı Dayama Burcu
- Üst Dayama Burcu
- Kamna
- Tutucu Pimleri
- Altı Dayama Takozu
- Gövde Yan Dayama Plakaları
- Kıncı Tamir Takımları
- Kıncı Diyaframları
- Cwf Marka Kıncı Keçeleri
- Stirrit Marka Kıncı Keçeleri
- Kıncı Gaz Basma Setleri

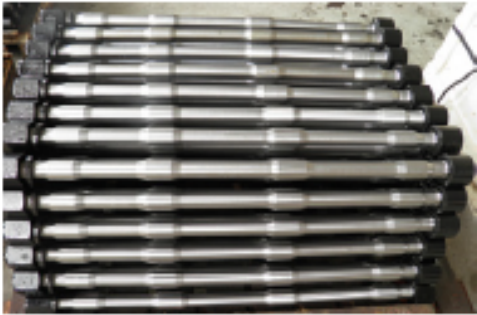
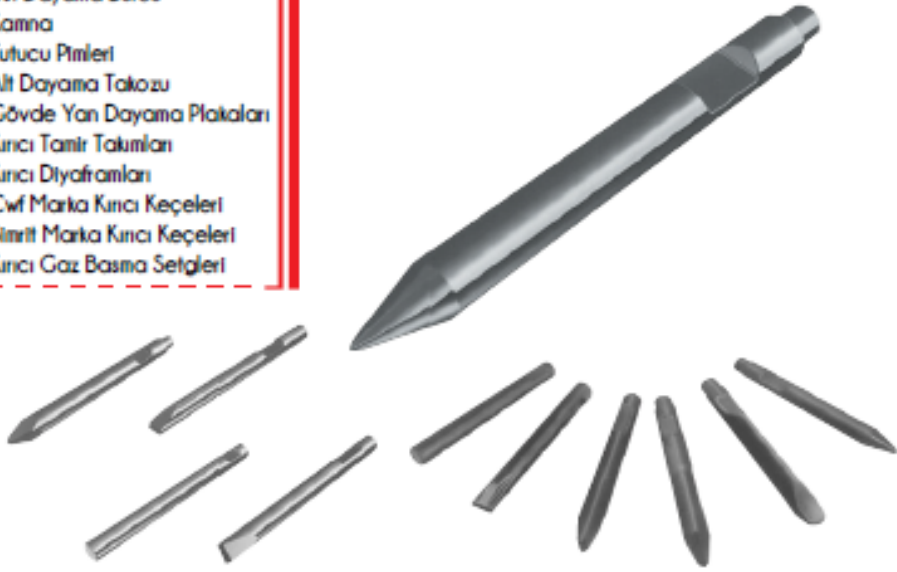

- Kıncı Tamir Takımları ve Diyaframları



COUPLING PARTS



Hidrolik Pompa
Kaplamları





CONSTRUCTION MACHINERY SPARE PARTS





PIN – BUSHING – KESTAMIT – SPECIAL PRODUCTION MANUFACTURING IN TURKIYE

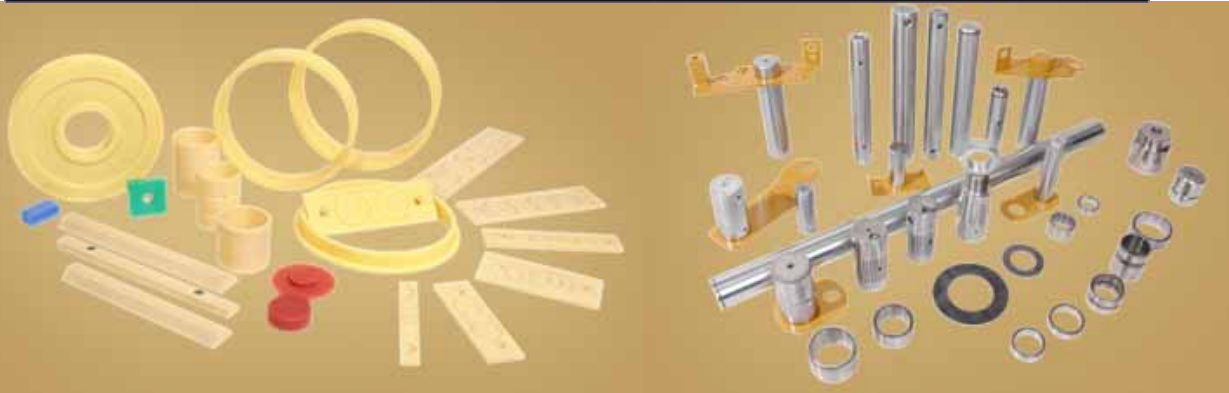



POWER TAKE OFF (PTO) EQUIPMENT MANUFACTURING IN TURKIYE



PTOS



SPLIT SHAFT PTO



SANDWICH PTO



TRANSFER CASE



Blower



PTO Accessories



RPM INCREASER/DECREASER



PUMP DRIVE



HYDRAULIC PUMP



WATER PUMP



FIRE TRUCK EQUIPMENT



CLUTCH SYSTEM



Worm Gear Mechanism



Hydraulic Equipment

REMAN AND REVISION IN TURKIYE



DİZEL MOTOR



ŞANZIMAN



DİFERANSİYEL



CER



ANA HİDROLİK POMPA



ANA KUMANDA VALF



KABİN



UÇ BOM



RADYATÖR



ANA BOM



LİFTLER



KULE





Hydraulic & Pneumatic Equipment and Parts

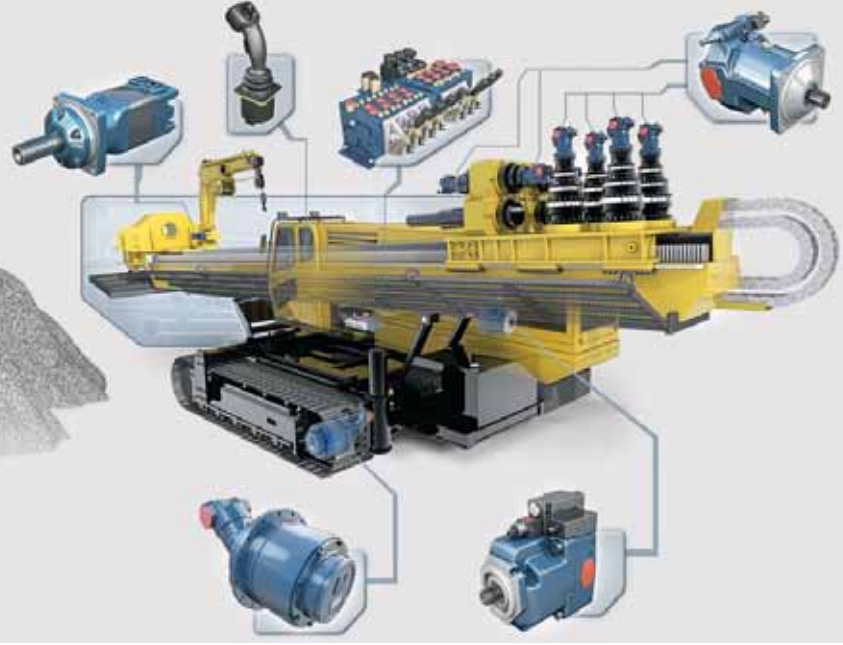
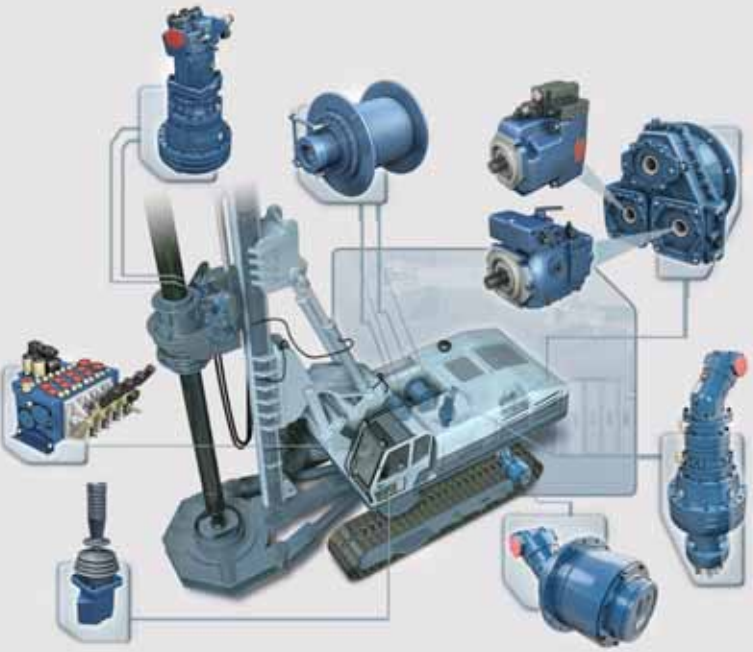



Hydraulic & Pneumatic Equipment and Parts





FORKLIFT / INDUSTRIAL TRUCK PARTS ORIGINAL OEM- OES- AFTER MARKET





FORKLIFT / INDUSTRIAL TRUCK PARTS





Mobile Elevating Work Platforms (MEWPs), Personnel Lifting Platform , Manlift , Aerial Work Platforms (AWP) Sector

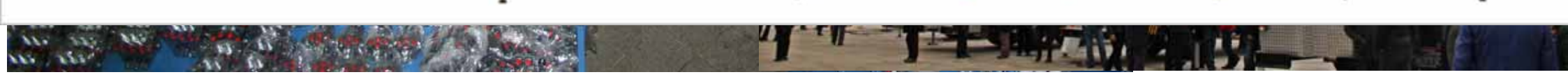



Mobile Elevating Work Platforms (MEWPs), Personnel Lifting Platform , Manlift ,
Aerial Work Platforms (AWP) , Telehandlers, Platform Sector
SPARE PARTS – ORIGINAL- OEM- OES





NEW AND USED TELEHANDLERS, MANLIFTS, AWP's SCISSOR LIFTS



SCISSOR LIFTS



SPIDER LIFTS



ARTICULATING BOOM LIFTS



DIESEL SCISSOR LIFTS



MAST LIFTS



TELESCOPIC BOOM LIFTS



TRAILER LIFTS



SOLID TIRES FOR ALL CONSTRUCTION MACHINERIES AND LISTING EQUIPMENT



REACH FORKLIFT TRUCKS

COUNTER BALANCE FORKLIFTS

ROUGH TERRAIN FORKLIFTS

SCISSOR LIFT

VERTICAL MAST LIFT

PUSH AROUND LIFT

ARTICULATED BOOM LIFT

TYRE ROLLER

SELF LOADING CONCRETE MIXER TRUCK

ROAD MILLING MACHINE

SIDE LOADER FORKLIFTS

TELESCOPIC HANDLER FORKLIFTS

TRAILER TRUCKS CONTAINER

MOTOR GRADER MACHINE

WHEEL BULLDOZER MACHINE

DUMPER TRUCK

TIPPER LORRY

ARTICULATED DUMPER

SELF LOADING CONCRETE MIXER

TELESCOPIC BOOM LIFT

TOWABLE BOOM LIFT

ROUGH TERRAIN SCISSOR LIFT

TELEHANDLER LIFT

SKID STEER LOADER

SCRAPER MACHINE

FRONT LOADER

SOLID TIRES FOR ALL CONSTRUCTION MACHINERIES AND LISTING EQUIPMENT



SKID STEER LOADER



SKID STEER AUGER DRILLING MACHINE



SNOW BLOWERS



ARTICULATED DUMP TRUCK



SLAG POT CARRIER



MOBILE CRANE



TRENCHER



HAMMER



TELEHANDLER



FRONT LOADER



BACKHOE LOADER



WHEEL BULLDOZER



UNDERGROUND SCISSOR LIFT



ARTICULATED DUMP TRUCK



GRAPPLE RAKE ATTACHED



SKID STEER SWEEPER BROOM



FRONT LOADER



SHIPYARD TRANSPORTER



SCRAPS HANDLER



TELEHANDLERS



SCOOPTRAM



UNDERGROUND ROCKBREAKER



UNDERGROUND BOOM LIFT



ROOF SUPPORT CARRIER

SOLID TIRES FOR ALL CONSTRUCTION MACHINERIES AND LISTING EQUIPMENT



SOLID LUG SOLID RIB SOLID SMOOTH



SOLID OTR SHORT LUG SOLID OTR LONG LUG SOLID OTR SMOOTH



UG MINING SOLID CROSS UG MINING SOLID RIB UG MINING SOLID Z



POB LUG STRAIGHT POB SMOOTH POB LUG ANGLE



PBB SOLID FLANGE TYPE PBB SOLID BEARING TYPE PBB SOLID STIFFENER TYPE



SOLID SKID STEER SOLID SMOOTH SKID STEER CURED ON WHEEL



GSE LUG TYRE GSE RIB TYRE GSE SMOOTH TYRE



END DISC RIM CENTER DISC RIM STIFFENER RIM



VEHICLE SPARE PARTS



SCANIA



IVECO

DAF





VEHICLE, TRUCK, BUS, LCV, HEAVY TRUCKS ORIGINAL SPARE PARTS





SPECIAL PARTS FOR ENGINES SPARE PARTS





AUTO PARTS - ORIGINAL AND AFTER-MARKET SPARE PARTS





Used & Second Hand Machinery and Trucks - Türkiye / Dubai / Netherland





TRACTOR AND AGRI MACHINERIES SPARE PARTS

Fastest , Safests, Largest After Market

Spare parts – Original, OEM and OES





TRACTOR AND AGRI MACHINERIES SPARE PARTS

Fastest , Safests, Largest After Market

Spare parts – Original, OEM and OES



TRACTOR AND AGRI MACHINERIES



TRACTOR AND AGRI MACHINERIES

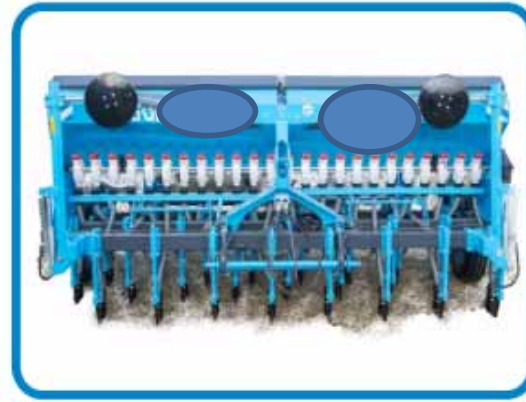



INTERNATIONAL RENTAL AND CONSTRUCTION FORUMS (2010 - 2022)

SENEGAL - RUSSIA- SOUTH AFRICA - CHILE - INDONESIA - SOUTH KOREA - INDIA - BRAZIL - AMERICA- BELGIUM – GERMANY

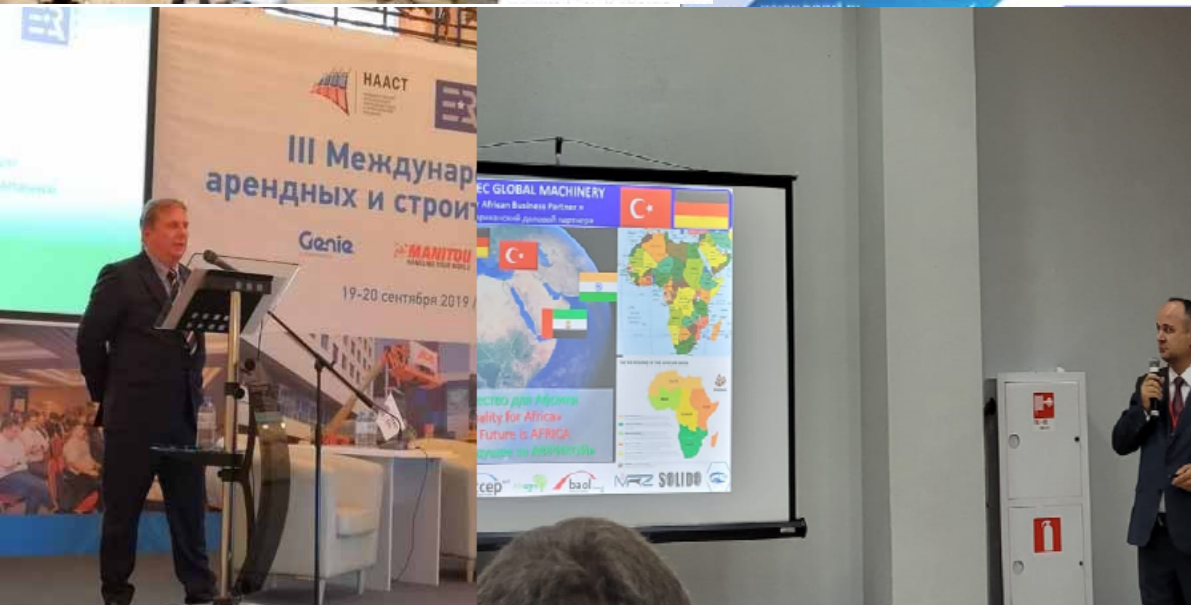

19 SEPTEMBER, 2019, EXHIBITION CENTER "NIZHEGORODSKAYA YARMARKA", MARINS PARK HOTEL, NIZHNY NOVGOROD

III INTERNATIONAL RENTAL AND CONSTRUCTION FORUM

SPEAKERS OF THE FORUM

| | | |
|----------------------|------------------------|-------------------------------|
| 1. Aksoy Faruk | 8. Kämpe Mikael | 15. Petitjean Michel |
| 2. Bachmann Carole | 9. Klimenko Valeriy | 16. Sautilis Toms |
| 3. Bisnieks Andris | 10. Klyuev Sergey | 17. Trishin Vasily |
| 4. Bocharnikov Pavel | 11. Kryukov Aleksandr | 18. Philippov Igor |
| 5. Wim de Jong | 12. Menjailov Aleksei | 19. Hilderink Willem |
| 6. Gomez Gloria | 13. Mihailov Aleksandr | 20. Shinkevich Pavel |
| 7. Grizenko Maxim | 14. Opolev Aleksandr | 21. Yarushevichiusi Aleksandr |

HAVE YOU DOWNLOADED YOUR EVENT APP?

HAACT
НАЦИОНАЛЬНАЯ
АССОЦИАЦИЯ
АРЕНДОДАТЕЛЕЙ
СТРОИТЕЛЬНОЙ
ТЕХНИКИ

www.naast.ru
forum@naast.ru
+7 (906) 418 64 73

#HAACT

#ФОРУМАРЕНДА2019





International Network and Meetings

USA, EU, Africa, Russia, China, India, S.Korea, Indonesia, Middle East etc...





International Network and Meetings

USA, Brazil, EU, Africa, Russia, China, India, S.Korea, Indonesia, Middle East etc...





International Network and Meetings

USA, Brazil, EU, Africa, Russia, China, India, S.Korea, Indonesia, Middle East etc...





GLOBALTURQ

CONSTRUCTION

ELECTRICAL

MACHINERY

HEALTH



AFERKO GLOBAL

İMTELSAN

SİFTAMEC

HEALTHTURQ

- *Construction Materials
- *Aluminium,PVC & Glass
- *Bathroom Cabinets
- *Kitchen Furniture
- *Furnitures
- *Paints
- *Doors

- *Electrical Materials
- *Lighting Poles
- *Transformator
- *Solar Energy
- *Generators
- *Lightings
- *Cables

- *Machinery Equipment
- *Agricultural Equipment
- *Construction Machinery
- *Automotive Parts

- *Laboratory Equipments
- *Medical Materials
- *Medicine Supply
- *Hospital Project
- *Health Tourism



AFERKO GLOBAL

"GLOBAL SOLUTION PARTNER"

BUILDING & CONSTRUCTIONS MATERIALS



ELECTRICAL, LIGHTING, ENERGY





GERMANY | TURKEY | SENEGAL | UAE | INDIA



GLOBALTURQ

Germany – Türkiye – Senegal – UAE - India



Faruk AKSOY

CEO/Executive Management Partner

SIFTAMEC Global Machinery Co.Ltd.

SIFTAMEC Global Makina Ltd.Sti

✉ faruk@siftamec.com 🌐 www.siftamec.com



📍 Meclis Mh. Teraziler Cd.
Derviş Sk. Fuat ÖZAL Plaza
No:38/104 34785 Sancaktepe
Istanbul/TURKEY

☎ +90 532 698 37 11
☎ +90 216 912 27 12

📍 SIDIO GROUP FAMILY
Boulevard Elymanel FALL x
Rue du Commerce BP:565
Diourbel- SENEGAL

☎ +221 772 153 442
☎ +221 33 971 18 38

www.siftamec.com
faruk@siftamec.com
GSM : +90532 698 37 11